

Panasonic

Operating Instructions

دفترچه راهنما

Microwave/Grill Oven

اجاق مایکروویو/کباب پز

Household Use Only

فقط استفاده خانگی



Panasonic Corporation
Web Site: <http://panasonic.net>

Model No. NN-GF574M

F0003BN00PT
IP1014-0

Before operating this oven, please read these instructions completely and keep for future reference.

قبل از استفاده از این دستگاه، لطفاً مطالب این دفترچه را به طور کامل بخوانید و آن را بر ای مراجعه در آینده نزد خود نگهدارید.

Table of Contents

Important Safety Instructions.....	2
Installation and General Instructions	3
Feature Diagram.....	4
Control Panel.....	5
Display Window.....	6
Clock Setting	6
To Use Child Safety Lock	6
To Reheat/Defrost/Cook by Setting Power and Time	7
To Defrost	8
Defrosting Tips and Techniques	9
To Cook on Grill by Time Setting	10
To Cook on Combination by Time Setting	11
3-Stage Setting.....	12
Auto Cook Setting.....	13
Auto Cook Menus	14-18
Timer Setting (Kitchen Timer/Standing Time/Delay Time).....	19
Before Requesting Service.....	20
Care of your Microwave Oven	21
Technical Specifications	21
Quick Guide.....	22

English

Important Safety Instructions

READ CAREFULLY AND KEEP FOR FUTURE REFERENCE

Precautions to be taken when using Microwave Ovens for Heating Foodstuffs

Inspection for Damage:

A microwave oven should only be used if an inspection confirms all of the following conditions:

1. The grille is not damaged or broken.
2. The door fits squarely and securely and opens and closes smoothly.
3. The door hinges are in good condition.
4. The metal plates of a metal seal on the door are neither buckled nor deformed.
5. The door seals are neither covered with food nor have large burn marks.

Precautions:

Microwave radiation from microwave ovens can cause harmful effects if the following precautions are not taken:

1. Never tamper with or deactivate the interlocking devices on the door.
2. Never poke an object, particularly a metal object, through a grille or between the door and the oven while the oven is operating.
3. Never place saucepans, unopened cans or other heavy metal objects in the oven.
4. Do not let other metallic articles, e.g. fast food foil containers, touch the side of the oven.
5. Clean the oven cavity, the door and the seals with water and a mild detergent at regular intervals. Never use any form of abrasive cleaner that may scratch or scour surfaces around the door.
6. Always use the oven with cookware recommended by the manufacturer.
7. Never operate the oven without a load (i.e. an absorbing material such as food or water) in the oven cavity unless specifically allowed in the manufacturer's literature.
8. For horizontally hinged doors, never rest heavy objects such as food containers on the door while it is open.
9. Do not place sealed containers in the microwave oven. Baby bottles fitted with a screw cap or a teat are considered to be sealed containers.
10. This appliance is not intended for use by persons (including children) with reduced physical, sensory or mental capabilities, or lack of experience and knowledge, unless they have been given supervision or instruction concerning use of the appliance by a person responsible for their safety.
11. Young children should be supervised to ensure that they do not play with the appliance.
12. It is hazardous for anyone other than a competent person to carry out any service or repair operation that involves the removal of a cover which gives protection against exposure to microwave energy.
13. The surfaces are liable to get hot during use.

Practical Hints:

1. For initial use of COMBINATION and GRILL, if you see white smoke arise, it is not malfunction.
2. Exterior oven surfaces, including air vents on the cabinet and the oven door will get hot during COMBINATION and GRILL. Use care when opening or closing door and when inserting or removing food and accessories.
3. The oven has a heater situated in the top of the oven. After using the GRILL and COMBINATION functions, the ceiling will be very hot.
4. The accessible parts may become hot when GRILL or COMBINATION is in use. Children should be kept away.

Important Instructions

WARNING—To reduce the risk of burns, electric shock, fire, injury to persons or excessive microwave energy:

1. Read all instructions before using microwave oven.
2. Some products such as whole eggs and sealed containers - (for example, closed glass jars **and sealed baby bottles with teat**) may explode and should not be heated in microwave oven. Refer to cookbook for more details.
3. Use this microwave oven only for its intended use as described in this manual.
4. As with any appliance, close supervision is necessary when used by children.
5. Do not operate this microwave oven, if it is not working properly, or if it has been damaged or dropped.
6. Do not store or use this appliance outdoors.
7. Do not immerse cord or plug in water.
8. Keep cord away from heated surfaces.
9. Do not let cord hang over edge of table or counter.
10. To reduce the risk of fire in the oven cavity:
 - (a) Do not overcook food. Carefully attend microwave oven if paper, plastic, or other combustible materials are placed inside the oven to facilitate cooking.
 - (b) Remove wire twist-ties from bags before placing bag in oven.
 - (c) If materials inside the oven should ignite, keep oven door closed, turn oven off at the wall switch, or shut off power at the fuse or circuit breaker panel.
 - (d) Never leave microwave unattended while cooking or reheating.
11. Do not remove outer panel from oven.
12. Appliances are not intended to be operated by means of an external timer or separate remote-control system.
13. Failure to maintain the oven in a clean condition could lead to deterioration of the surface that could adversely affect the life of the appliance and possibly result in a hazardous situation.

Circuits

Your microwave ovens should be operated on a separate circuit from other appliances. The voltage used must be the same as specified on this microwave oven. Failure to do this may cause the power board fuse to blow, and/or food to cook slower.

Do not insert higher value fuse in the power board.

Earthing Instructions

This microwave oven must be earthed. In the event of an electrical short circuit, earthing reduces the risk of electric shock by providing an escape wire for the electric current. This microwave oven is equipped with an earthing plug. The plug must be plugged into an outlet that is properly installed and earthed.

WARNING—Improper use of the earthing plug can result in electric shock.

Installation and General Instructions

General Use

1. In order to maintain high quality, do not operate the oven when empty. The microwave energy will reflect continuously throughout the oven if no food or water is present to absorb energy. This can lead to damage to the microwave oven including arcing within the oven cavity.
2. If smoke is observed, press the **Stop/Reset** Pad and leave door closed. Disconnect the power cord, or shut off power at the fuse or circuit breaker panel.
3. Do not dry clothes, newspapers or other materials in oven. They may catch on fire.
4. Do not use recycled paper products, as they may contain impurities which may cause sparks and/or fires when used.
5. Do not use newspapers or paper bags for cooking.
6. Do not hit or strike control panel. Damage to controls may occur.
7. POT HOLDERS may be needed as heat from food is transferred to the cooking container and from the container to the flat table. The flat table can be very hot after removing the cooking container from the oven.
8. Do not store flammable materials next to, on top of, or in the oven. It could be a fire hazard.
9. Do not cook food directly on flat table unless indicated in recipes. (Food should be placed in a suitable cooking utensil.)
10. **DO NOT** use this oven to heat chemicals or other non-food products. **DO NOT** clean this oven with any product that is labeled as containing corrosive chemicals. **The heating of corrosive chemicals in this oven may cause microwave radiation leaks.**
11. When using the COMBINATION mode, never place any aluminum or metal container directly on the wire rack. Always insert a heat-proof, glass plate or dish between the wire rack and the aluminum container. This will prevent sparking that may damage the oven.
12. It is recommended not to use the wire rack when cooking in the MICROWAVE mode only.
13. During cooking, some steam will condense inside and/or on the oven door. This is normal and safe. Steam will disappear after the oven is cool down.
14. The microwave oven is intended for heating food and beverages. Drying of food or clothing and heating of warming pads, slippers, sponges, damp cloth and similar may lead to risk of injury, ignition or fire.
15. During use the appliance becomes hot. Care should be taken to avoid touching heating elements inside the oven.

Placement of Oven

1. The oven must be placed on a flat, stable surface, more than 85 cm above the floor. For correct operation, the oven must have sufficient air flow. Allow 15 cm of space on the top of the oven, 10 cm at back and 5 cm on both sides. If one side of the oven is placed flush to a wall, the other side or top must not be blocked. Do not remove feet.

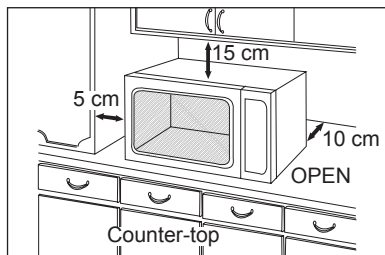

- (a) Do not block air vents. If they are blocked during operation, the oven may overheat. If the oven overheats, a thermal safety device will turn the oven off. The oven will remain inoperable until it has cooled.

- (b) Do not place oven near a hot or damp surface such as a gas stove, electric range or sink etc.
- (c) Do not operate oven when room humidity is too high.
2. This appliance is intended to be used in household and similar applications such as: staff kitchen areas in shops, offices and other working environments; farm house; by clients in hotels, motels and other residential environments; bed and breakfast type environments.

Food

1. Do not use your oven for home canning or the heating of any closed jar. Pressure will build up and the jar may explode. In addition, the microwave oven cannot maintain the food at the correct canning temperature. Improperly canned food may spoil and be dangerous to consume.
2. Do not attempt to deep fat fry in your microwave oven.
3. Do not boil eggs in their shell (unless otherwise stated in cookbook). Pressure will build up and the eggs will explode.
4. Potatoes, apples, egg yolks, whole squash and sausages are examples of foods with nonporous skins. This type of food must be pierced before cooking, to prevent bursting.
5. When heating liquids, e.g. soup, sauces and beverages in your microwave oven, overheating the liquid beyond boiling point can occur without evidence of bubbling. This could result in a sudden boil over the hot liquid. To prevent this possibility the following steps should be taken.
 - (a) Avoid using straight-sided containers with narrow necks.
 - (b) Do not overheat.
 - (c) Stir the liquid before placing the container in the oven and again halfway through cooking time.
 - (d) After heating, allow to stand in the oven for a short time, stirring again before carefully removing the container.
6. **DO NOT USE A CONVENTIONAL MEAT THERMOMETER IN THE MICROWAVE OVEN. To check the degree of cooking of roasts and poultry use a MICROWAVE THERMOMETER.** Alternatively, a conventional meat thermometer may be used after the food is removed from the oven. If undercooked, return meat or poultry to the oven and cook for a few more minutes at the recommended power level. It is important to ensure that meat and poultry are thoroughly cooked.
7. **COOKING TIMES given in the cookbook are APPROXIMATE.** Factors that may affect cooking time are preferred degree of moisture content, starting temperature, altitude, volume, size, shape of food and utensils used. As you become familiar with the oven, you will be able to adjust for these factors.
8. It is better to **UNDERCOOK RATHER THAN OVERCOOK** foods. If food is undercooked, it can always be returned to the oven for further cooking. If food is overcooked, nothing can be done. Always start with minimum cooking times recommended.
9. Extreme care should be taken when cooking popcorn in a microwave oven. Cook for minimum time as recommended by manufacturer. Use the directions suitable for the wattage of your microwave oven. **NEVER** leave oven unattended when popping popcorn.
10. When heating food in plastic or paper containers, check the oven frequently due to the possibility of ignition.
11. The contents of feeding bottles and baby food jars are to be stirred or shaken and the temperature is to be checked before consumption, in order to avoid burns.

Feature Diagram

English

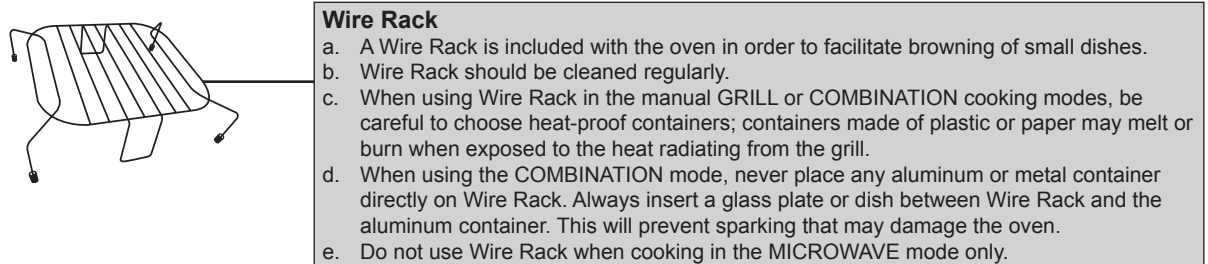
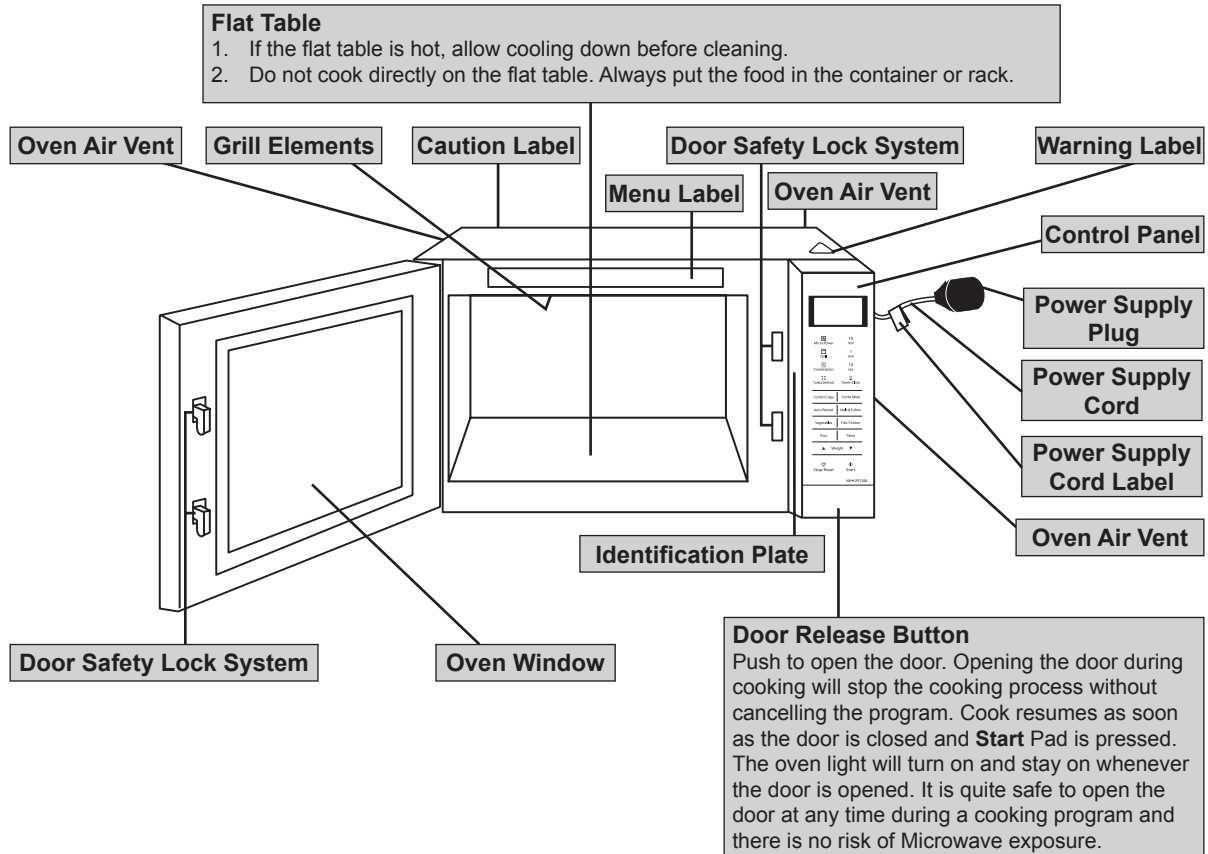

Note:
 The illustration is for reference only.

Oven Light:
 Oven Light will turn on during cooking and also when door is opened.

Warning

- The door seals and door seal areas should be cleaned with a damp cloth. The appliance should be inspected for damage to the door seals and door seal areas and if these areas are damaged the appliance should not be operated until it has been repaired by a service technician trained by the manufacturer.
- It is dangerous for anyone other than a service technician trained by the manufacturer to perform repair service.
- If the supply cord of this appliance is damaged, it must be replaced by the manufacturer or its service agent or a similarly qualified person in order to avoid a hazard.
- Before use, the user should check that whether the utensils are suitable for use in microwave ovens.
- Liquids or other foods must not be heated in sealed containers since they are liable to explode, at the same time it should avoid the boiling liquids splash.
- Only allow children to use the oven without supervision when adequate instructions have been given so that the child is able to use the oven in a safe way and understands the hazards of improper use.
- When the appliance is operated in the grill or combination modes, children should only use the oven under adult supervision due to the temperatures generated.

Control Panel

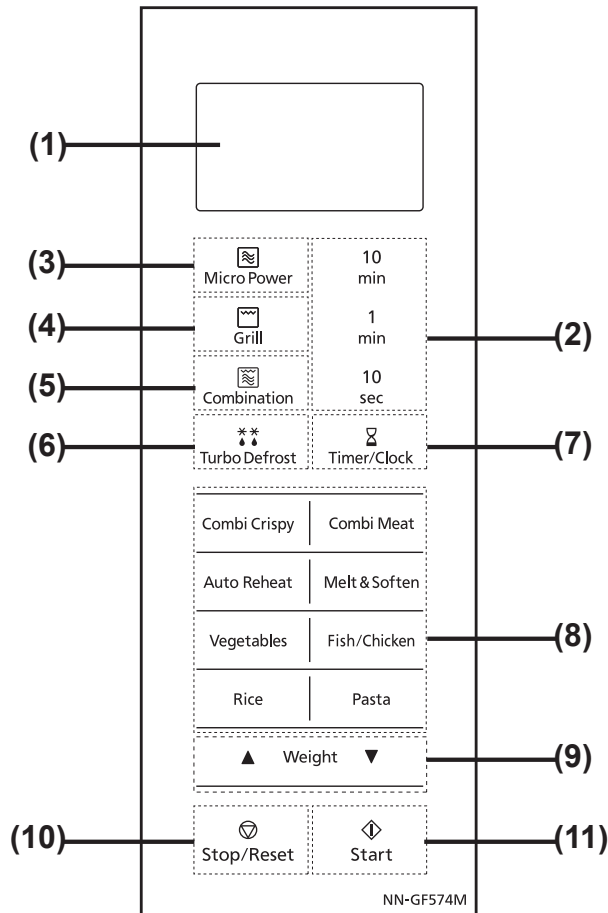

- (1) **Display Window**
- (2) **Time Pads**
- (3) **Micro Power Pad**
- (4) **Grill Pad**
- (5) **Combination Pad**
- (6) **Turbo Defrost Pad**
- (7) **Timer/Clock Pad**
- (8) **Auto Cook Menu Pads**
- (9) **Weight Pads**
- (10) **Stop/Reset Pad**

Before Cooking: One tap clears your instructions.

During Cooking: One tap temporarily stops the cooking process. Another tap cancels all your instructions and colon or time of day appears in the Display Window.

- (11) **Start Pad**
One tap allows oven to begin functioning. If door is opened or **Stop/Reset** Pad is tapped once during oven operation, **Start** Pad must again be pressed to restart oven.

Beep Sound:

When a pad is pressed correctly, a beep will be heard.

If a pad is pressed and no beep is heard, the unit did not or cannot accept the instruction. The oven will beep twice between programmed stages. At the end of any complete program, the oven will beep 5 times.

Note:

If no any operation after cooking program setting, 6 minutes later, the oven will automatically cancel the cooking program. The display will revert back to clock or colon display.

Display Window

To help you operate the oven conveniently, the present state will appear in the Display Window.

English

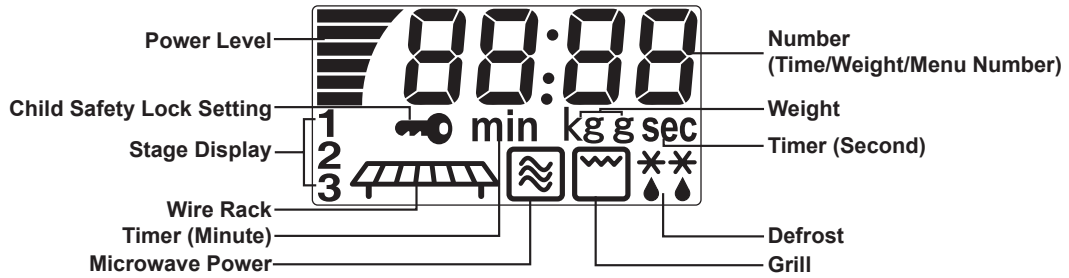

Clock Setting

You can use the oven without setting the clock. The clock is an optional function for the user. Its accuracy may be affected by the local power supply condition.

To Set Clock: Example: To set 11:25 a.m.

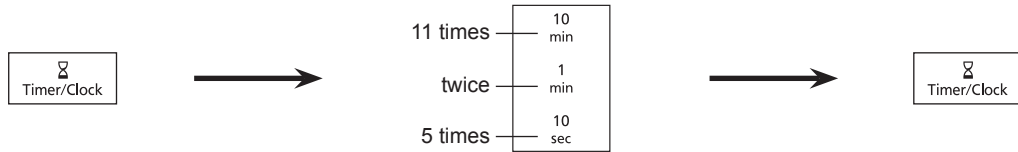

1. Press twice. Colon will blink in the display window.
2. Enter time of day using the **Time Pads**. Time appears in the display window; colon is blinking.
3. Press once. Colon stops blinking; time of day is entered and locked in the display window. Time counts up in minutes.

Notes:

1. To reset time of day, repeat steps 1-3.
2. The clock will keep the time of day as long as oven is plugged in and electricity is supplied.
3. Clock is a 12-hour display.
4. Oven will not operate while colon is blinking.

To Use Child Safety Lock

This feature allows you to prevent operation of the oven by a young child. You can set Child Safety Lock when colon or time of day is displayed.

To set:



Press **Start** Pad 3 times.
▶ "🔑" appears in the display window.

Press 3 times

To cancel:



Press **Stop/Reset** Pad 3 times.
▶ Colon or time of day appears in the display window.

Press 3 times

Note:

To set or cancel child safety lock, **Start** Pad or **Stop/Reset** Pad must be pressed 3 times within 10 seconds.

To Reheat/Defrost/Cook by Setting Power and Time

This feature allows you to set the desired power and time for cooking by yourself.

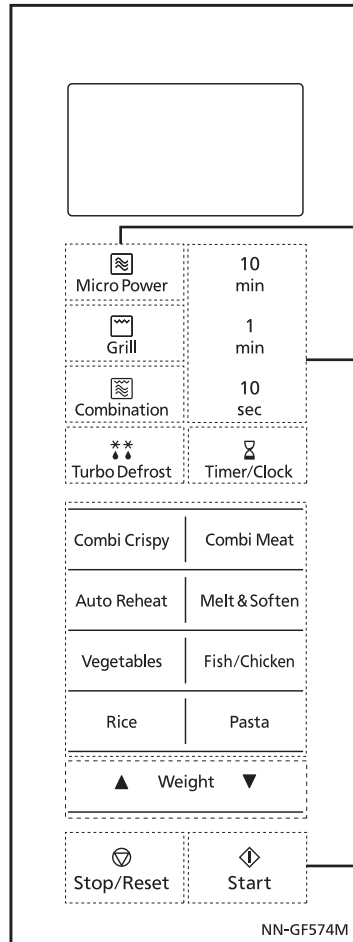

1. Put the food into the oven



2. Select Microwave Power Level

Press **Micro Power** Pad until the desired power level appears in the Display Window. (see chart below)

3. Set Cooking Time

Press **Time** Pads until the desired cooking time appears in the Display Window.

Example: Select 12 minutes and 30 seconds.

once	10 min
twice	1 min
3 times	10 sec

Maximum Length of cooking time:

High Power: up to 30 minutes
Other Powers: up to 99 minutes 50 seconds

4. Press

The time in the display window will count down.

Notes:

- When selecting High Power on the first stage, you can skip step 2.
- For more than one stage cooking, repeat steps 2 & 3 above then press **Start**. The maximum number of stages for cooking is 3.
- The oven will beep twice between stages. For the details, please refer to page 12.

Micro Power:

The **Micro Power** Pad gives you a selection of different power levels representing decreasing amounts of microwave energy, used for cooking foods at different speeds.

E.g. The lower the micro power setting, the more evenly the food cooks, although it will take a little longer.

To select the correct power level for cooking different foods, refer to the chart below.

Press	Power Level	Display	Example of Use
once	HIGH (1000 W)		Boil water, cook fresh fruit, fresh vegetables, and confectionery, and heat non-milk beverages.
twice	MEDIUM-HIGH (700 W)		Cook fish, shellfish, cakes, meats, poultry, eggs and cheese.
3 times	MEDIUM (600 W)		Cook custards and casserole, and melt butter and chocolate.
4 times	MEDIUM-LOW (450 W)		Cook less tender cuts of meat, simmer soups and stews, and soften butter and cream cheese.
5 times	DEFROST (350 W)		Defrost meat, poultry and seafood.
6 times	LOW (250 W)		Keep foods warm, proof yeast, soften ice cream, and make yoghurt.

To Defrost

Turbo Defrost

This feature allows you to defrost meat, poultry and seafood by weight. Weight must be programmed in kilograms.

English

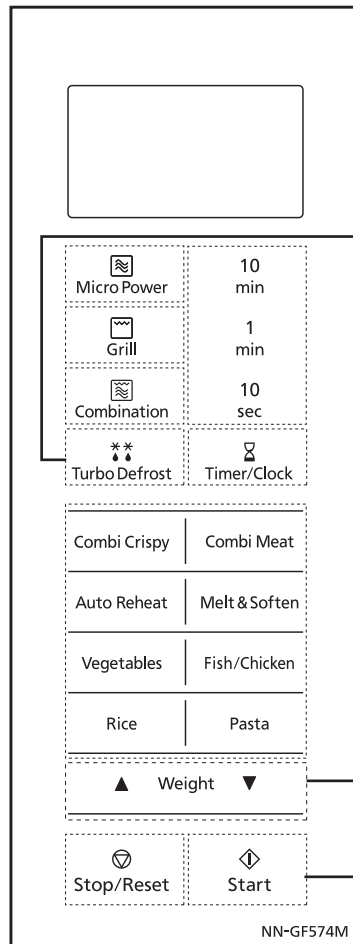

1. Put the food into the oven

Appropriate type of food for Turbo Defrost
Meat loaf, chicken, rib
Beef, lamb, whole chicken
Whole fish, shellfish, prawn and fish fillet

2. Press once to select the Turbo Defrost

3. Select the Weight of food

Press **Weight Pads** or **Turbo Defrost Pad** until the desired weight appears in the Display Window.

Example: To Defrost 1.5 kg of meat.



The Display Window appears:



The weight can be set between 0.1 kg to 3.0 kg.

4. Press

The time in the display window will count down.

Notes:

1. Turbo Defrost can be used to defrost many cuts of meat, poultry and fish by weight. To use, simply program Turbo Defrost and the weight of the food in kg (1.0) and tenths of a kg (0.1). The oven will determine the defrosting time and power levels. Once the oven is programmed, the defrosting time will appear in the display. For best results the minimum recommended weight is 0.2 kg.
2. BONE-IN ROASTS, such as a Beef Rib Roast have a smaller muscle than a boneless roast of the same weight. Therefore, for bone-in roasts weighing over 2 kg reduce weight by 0.5 kg. For bone-in roasts weighing less than 2 kg, reduce weight by 0.25 kg.
3. Turn over the food, remove defrosted food and shield thin ends/fat bones of roast with foil when buzzer rings in the middle of cooking.

Time Defrost

If you want to decide the defrost time by yourself, please select this pad and operate the following. (see page 7 for direction)

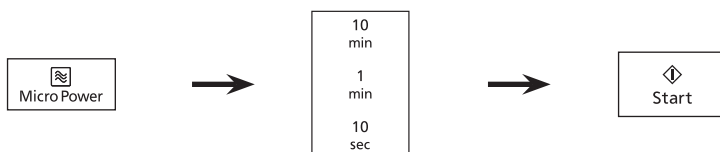

1. Press 5 times.

2. Select defrost time.

3. Press.

Note:

Opening the door and taking out the defrosted parts during the operating time is recommended. Turn over, stir or rearrange the parts which are still in icy.

Defrosting Tips and Techniques

Preparation for Freezing

The quality of the cooked foods comes from the foods before freezing, freezing ways and defrosting tips and times. So it is important to purchase fresh and high quality foods. And freeze them immediately. Thick plastic foil, package, freezing

wrap and the meat which has been sealed before selling are all able to be reserved in the refrigerator for some times.

Note: Please remove the aluminum foil if the package is made of aluminum to prevent arcing.

Notes:

1. When freezing meats, poultry and fish or seafood, the foods should be arranged evenly and wrap as 2.5-5 cm square or a round shape.
2. Please clean the whole chicken before freezing. (The bowels can be frozen individually.) Clean the whole chicken and make it dry. Binding the leg and thigh.
3. Remove all air and seal securely. Label package with type and cut of meat, date and weight.

The foods in the refrigerator should be kept under -18 °C. (At least 24 hours in freezer before defrosting.)

Turbo Defrost

The turbo defrost function is operated based on the weight of foods. Most cut foods such as chicken, meat and fish can be defrosted by using this function easily. Select the weight based on the real weight of foods, and the microwave oven will set the power and time automatically. The display window will display the time of defrost after setting. The foods listed in the below table are the most suitable for using defrost function. The minimize weight is 0.1 kg and the maximum is 3.0 kg for getting the best result.

Foods	The maximum weight for the foods
Meat loaf, chicken, rib	2 kg
Beef, lamb, whole chicken	3 kg
Whole fish, shellfish, prawn and fish fillet	1 kg

Tips for turbo defrost

Meat, which is with bones. For example, if the meat with bones has the same weight as the pure meat, the meat in the former one is lighter than the latter one. So, subtract 0.5 kg for 2 kg meat with bones is better for defrosting and 0.2-0.3 kg for meat with bones which is less than 2 kg.

Two buzz beeps

Turn over the meat, chicken, fish and shellfish. Separate the stewed meat, chicken pieces and meat loaf. Apart the meat loaf from the hamburger. Shield the edge of chicken wings, roast, fat or bones.

Key to defrosting

For evenly defrosting, turn over the foods or move the position of the foods in the containers during the progress of defrosting.



Remove the package of the raw meat and place it on the plate.



Shield the front part of the chicken drumsticks by using aluminum foil.

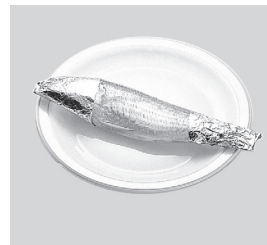

Shield the head and tail of the whole fish by using aluminum foil.

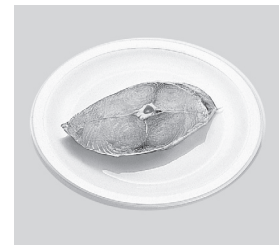

Remove the package of the fish fillet and place it on the plate.

To Cook on Grill by Time Setting

There are three grill setting modes. (1 - High, 2 - Medium, 3 - Low)

Directions for Grill Cooking:

There are three power levels for grill. When grilling, heat is radiated from the two quartz tubes at the top of the oven. The oven door must be kept closed to prevent cooking odours from spreading in the kitchen and so as not to waste energy. The grill is particularly useful for thin slices of meat, steaks chops, kebabs, sausages or pieces of chicken.

Put food on Wire Rack, with a shallow dish underneath to collect drips and place them on the center of flat table. Select Grill setting, set the time and start the oven. The food being grilled should normally be turned over after half the grilling time. When the oven door is opened, the program is interrupted. Turn the food over, place it back the oven, close the door and restart oven. While grilling, the oven door can be opened at any time to check the food.

English

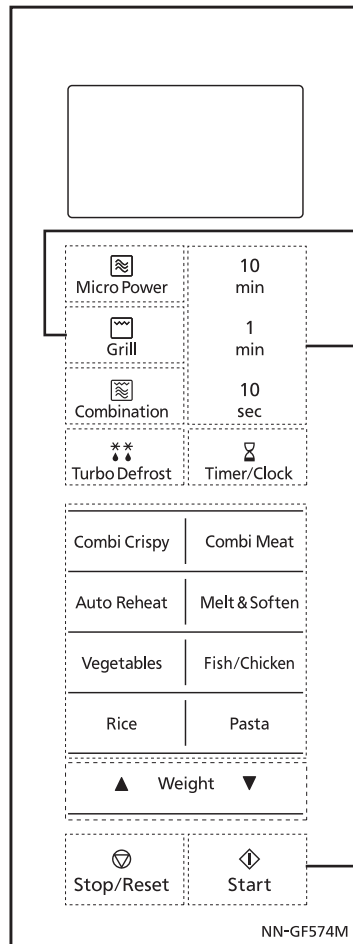

1. Put the food into the oven

2. Select Grill Setting

Press	Display	Power Level	Type of Food
once	≡	Grill 1 (HIGH)	Garlic Bread, Toast
twice	=	Grill 2 (MEDIUM)	Seafood
3 times	-	Grill 3 (LOW)	Meat, Poultry pieces

3. Set Cooking Time

(up to 99 minutes and 50 seconds)

4. Press

The time in the display window will count down.

Oven accessories to use

When grilling foods, the wire rack should be in the oven and put a dish on the flat table to catch drips.

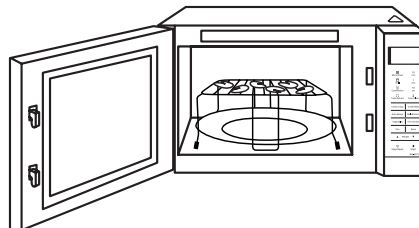

To Cook on Combination by Time Setting

There are three combination setting modes.

Directions for Combination Cooking:

There are three power levels for combination. It's a good way for roasting foods by combining microwave and grill effectively. It's suitable for roasting poultry, meat and seafood. This function can ensure the foods even cooking and keep the crispness of certain foods. Please open the door and turn over the foods when half of the cooking time, then continue cooking.

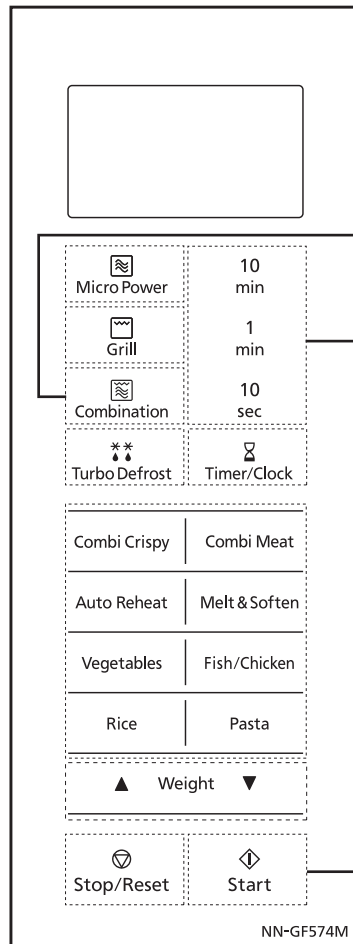

1. Put the food into the oven

2. Select Combination Setting

Press	Display	Power Level	Type of Food
once	≡ [Micro] [Grill]	Combination 1 (HIGH)	Baked potatoes, Whole poultry
twice	= [Micro] [Grill]	Combination 2 (MEDIUM)	Beef, Lamb
3 times	- [Micro] [Grill]	Combination 3 (LOW)	Sea food, Puddings

3. Set Cooking Time
(up to 99 minutes and 50 seconds)

4. Press
The time in the display window will count down.

Oven accessories to use

When cooking foods with combination function, you can put food in a heat-proof dish on the flat table directly. Alternatively you can put food on the wire rack, wire rack can be used for better browning result.

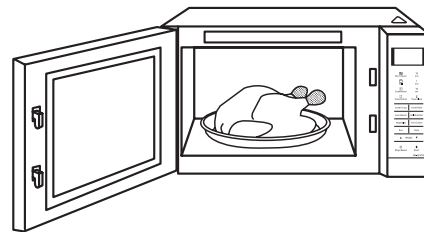
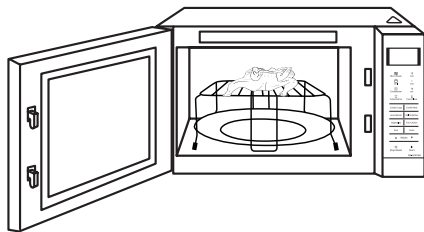

3-Stage Setting

This feature allows you to program 2-3 Stages of cooking continuously.

Example: Continually set [Medium power] 2 minutes, [Combination 1] 3 minutes and [Grill 2] 2 minutes.

English

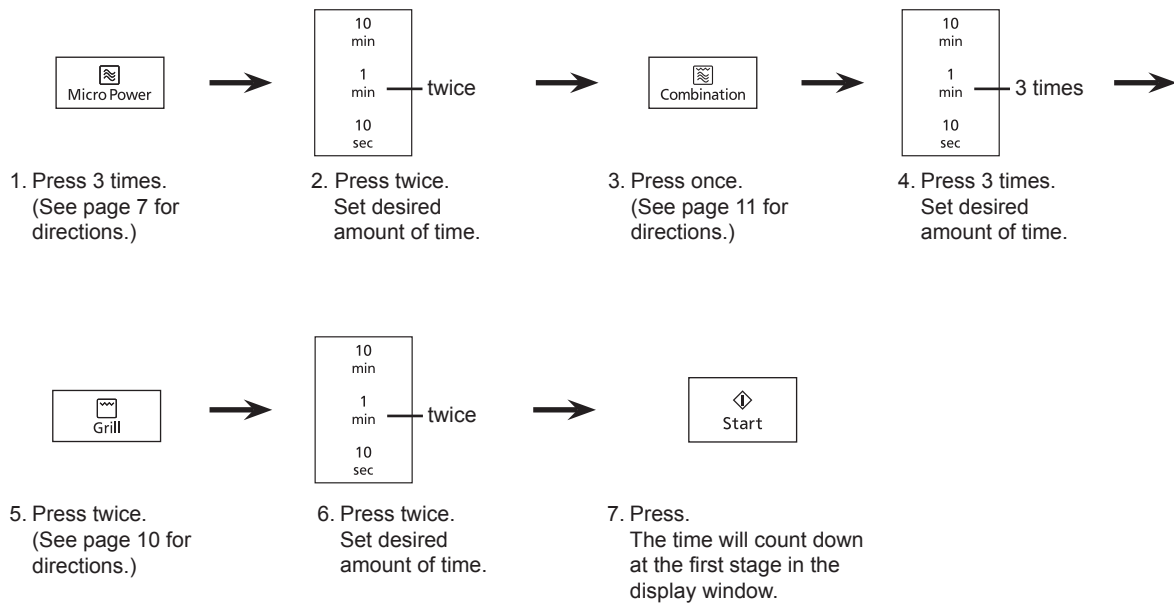

Notes:

1. When selecting high power on the first stage, you can skip step 1.
2. When operating, two beeps will sound between each stage.
3. Turbo Defrost and Auto Cook can not be used with 3-stage cooking.

Auto Cook Setting

This feature allows you to set some ordinary menus with different weights. It will cook automatically without setting power and time. Select the category of food and then just enter the weight. Do not include the weight of any added water or the container weight.

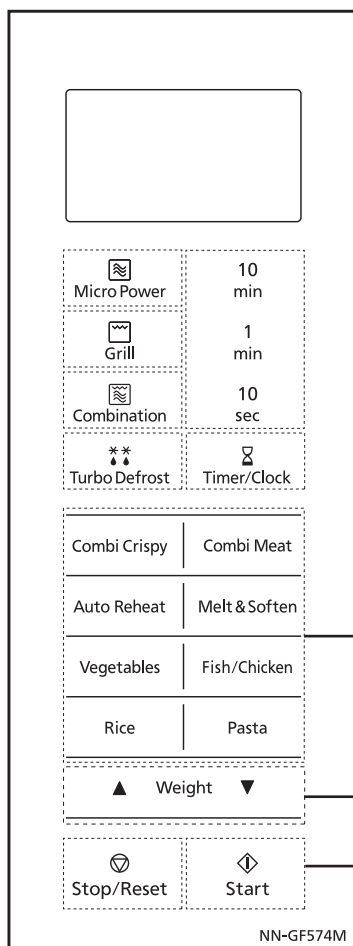

1. Put the food into the oven

2. Select Auto Cook Menu

Press the desired **Auto Cook Menu** Pad until the desired menu number appears in the display window.

3. Select the desired weight

Press the **Weight** Pads until the desired serving/weight appears in the Display Window.

4. Press

The cooking time appears in the display window and begins to count down.

Note:

When you select an auto cook menu, symbols will appear in the display to show the cooking mode that will be used and the accessories that are needed.

Ingredient Conversion Chart			
¼ cup	60 ml	¼ teaspoon	1 ml
⅓ cup	85 ml	½ teaspoon	2 ml
½ cup	125 ml	1 teaspoon	5 ml
⅔ cup	165 ml	2 teaspoons	10 ml
¾ cup	190 ml	3 teaspoons	15 ml
1 cup	250 ml	1 tablespoon	15 ml
1¼ cups	310 ml	1½ tablespoons	22 ml
1½ cups	375 ml	2 tablespoons	30 ml
2 cups	500 ml	3 tablespoons	45 ml
3 cups	750 ml	4 tablespoons	60 ml
3½ cups	875 ml		
4 cups	1 litre		
6 cups	1.5 litre		
8 cups	2 litre		

All recipes are tested using standard measurement that appear in the above chart.

Auto Cook Menus

Combi Crispy

Combi Crispy



Menu Number	Menu	Weight						Recommended Containers
		100 g	200 g	300 g	400 g	-	-	
1	Reheat Chilled Pizza	100 g	200 g	300 g	400 g	-	-	wire rack with a dish underneath
2	Reheat Fried Food	200 g	400 g	600 g	800 g	-	-	

1. Reheat Chilled Pizza

It is suitable for reheating chilled pizza. Place pizza on the wire rack, with a shallow dish underneath to collect drips and place them at the center of the flat table. Select the program and weight then press **Start**. **DO NOT USE PLASTIC WRAP OR LID.**

Notes:

1. Set the cooking time manually according to the actual weight when it does not conform to the weight specified in the operation instruction.
2. No need to use aluminum foil or grease.

2. Reheat Fried Food

It is suitable for reheating most kinds of fried foods, like fried chicken, curry puffs, fried spring rolls and etc. Arrange fried foods on wire rack, with a shallow dish underneath to collect drips and place them at the center of the flat table. Select the program and weight then press **Start**. Open the door to **TURN OVER WHEN TWO BEEPS HEARD** during cooking, press **Start** Pad to continue. **DO NOT USE PLASTIC WRAP OR LID.**

Combi Meat

Combi Meat



Menu Number	Menu	Weight						Recommended Containers
		600 g	900 g	1200 g	1500 g	-	-	
3	Roast Chicken	600 g	900 g	1200 g	1500 g	-	-	wire rack with a dish underneath
4	Grill Chicken Pieces	200 g	400 g	600 g	800 g	-	-	
5	Beef Kebab	200 g	400 g	600 g	800 g	-	-	

3. Roast Chicken

It is suitable for roasting whole chicken. Clean the chicken and cut open from breast, then marinate it for about 1 hour with seasonings. Put the prepared chicken skin side up on wire rack (see below illustration), with a shallow dish underneath to collect drips and place them at the center of the flat table. Select the program and weight then press **Start**. **DO NOT USE PLASTIC WRAP OR LID.**

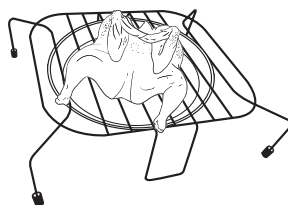

4. Grill Chicken Pieces

It is suitable for grilling chicken pieces. Make the chicken pieces clean and marinate them with seasoning for 1 hour. Place marinated chicken pieces on the wire rack, with a shallow dish underneath to collect drips and place them at the center of the flat table. Select the program and weight then press **Start**. Open the door to **TURN OVER WHEN TWO BEEPS HEARD** cooking, press **Start** Pad to continue. **DO NOT USE PLASTIC WRAP OR LID.**

5. Beef Kebab

It is suitable for grilling beef skewer. Marinate the food with seasoning for 1 hour. Place the food on the wire rack, with a shallow dish underneath to collect drips and place them at the center of the flat table. Select the program and weight then press **Start**. Open the door to **TURN OVER WHEN TWO BEEPS HEARD** during cooking, press **Start** Pad to continue. **DO NOT USE PLASTIC WRAP OR LID.**

Auto Reheat Auto Reheat

Menu Number	Menu	Weight						Recommended Containers
		1 Serv.	2 Serv.	3 Serv.	4 Serv.	-	-	
6	Reheat Meal	1 Serv.	2 Serv.	3 Serv.	4 Serv.	-	-	microwave safe dish with a lid or plastic wrap
7	Reheat Bread	100 g	200 g	300 g	500 g	-	-	microwave safe dish
8	Frozen Reheat	100 g	150 g	200 g	250 g	-	-	microwave safe dish with a plastic wrap

6. Reheat Meal

It is suitable for reheating Pre-cooked foods at refrigerator temperature (5-7 °C). Put meal into a suitable size microwave safe casserole, add 1-4 tbsp. water if desired, and cover with a lid or plastic wrap. Place container at the center of the flat table. Select the program and weight then press **Start**. Open the door to **STIR WHEN TWO BEEPS HEARD** during cooking, press **Start** Pad to continue.

Note: 1 serv. = 200 g

7. Reheat Bread

It is suitable for reheating bread at refrigerator temperature (5-7 °C). Put the bread on a suitable size microwave safe dish and place container at the center of the flat table. Select the program and weight then press **Start**. **DO NOT USE PLASTIC WRAP OR LID.**

8. Frozen Reheat

It is suitable for steaming some dessert such as buns. It's not suitable for big size food and all kinds of frozen dumplings. Food can be directly cooked by microwave oven from the fridge. Put food in a microwave safe dish and spread some water on them before cooking. Space between food must be left to prevent swelling after cooking and becoming hard under stress. Cover with plastic wrap and place the dish at the center of flat table. Select the program and weight then press **Start**.

Melt & Soften Melt & Soften

Menu Number	Menu	Weight						Recommended Containers
		50 g	100 g	150 g	200 g	250 g	300 g	
9	Chocolate	50 g	100 g	150 g	200 g	250 g	300 g	microwave safe dish
10	Butter	50 g	100 g	150 g	200 g	250 g	300 g	microwave safe dish with a lid or plastic wrap
11	Cheese	50 g	100 g	150 g	200 g	250 g	300 g	
12	Ice Cream	200 g	500 g	1000 g	2000 g	-	-	-

9. Chocolate

Remove wrapper, separate chocolate into small pieces, and place in a microwave safe dish. Cook without cover. Open the door to **STIR WHEN TWO BEEPS HEARD** during cooking, press **Start** Pad to continue. After heating, stir until completely melted. If food needs more time cooking or weight exceeds range, cook using Defrost for melting.

Note: Chocolate holds its shape even when softened.

10. Butter

Remove wrapper, cut butter into 3 cm cube, and place into a microwave safe dish. Melt with a lid or plastic wrap. Stir after cooking. If food needs more time cooking or weight exceeds range, cook using Defrost for melting.

11. Cheese

It is suitable for softening cream cheese. Remove wrapper, cut cheese into 3 cm cube, and place into a microwave safe dish. Soften with a lid or plastic wrap. If food needs more time cooking or weight exceeds range, cook using Defrost for softening.

12. Ice Cream

Soften slightly without lid. If food needs more time cooking or weight exceeds range, cook using Defrost for softening.

Vegetables Vegetables

English

Menu Number	Menu	Weight						Recommended Containers
		100 g	200 g	300 g	400 g	-	-	
13	Vegetables	100 g	200 g	300 g	400 g	-	-	microwave safe container with a lid or plastic wrap
14	Root Vegetables	180 g	250 g	370 g	500 g	-	-	
15	Jacket Potatoes	250 g	370 g	500 g	900 g	-	-	microwave safe container
16	Frozen Vegetables	120 g	250 g	500 g	700 g	-	-	microwave safe container with a lid or plastic wrap

13. Vegetables

It is suitable for cooking different kinds of leaf vegetables. Clean the vegetables and place them in a microwave safe container, add some oil and stir. Cover with a lid or plastic wrap and place container at the center of the flat table. Select the program and weight then press **Start**. Open the door to **STIR WHEN TWO BEEPS HEARD** during cooking, press **Start** Pad to continue. Add salt and other seasonings after cooking, then stir.

14. Root Vegetables

It is suitable for cooking root vegetables such as potato and carrot. Cut them into pieces and arrange them in a microwave safe container, add water if you prefer a softer cooked texture. Cover with a lid or plastic wrap and place container at the center of the flat table. Select the program and weight then press **Start**. Open the door to **STIR WHEN TWO BEEPS HEARD** during cooking, press **Start** Pad to continue. Add salt and other seasonings after cooking, then stir.

15. Jacket Potatoes

It is suitable for cooking potatoes. For best result, please keep potato 150-200 g each. Put a light cross-notch on the surface of potatoes with a kitchen knife. Arrange prepared potatoes in a microwave safe container and place it at the center of the flat table. Select the program and weight then press **Start**. Open the door to **TURN OVER AND ARRANGE WHEN TWO BEEPS HEARD** during cooking, press **Start** Pad to continue. **DO NOT USE PLASTIC WRAP OR LID.**

16. Frozen Vegetables

It is suitable for cooking different kinds of frozen vegetables. Put them in a microwave safe container, add water if you prefer a softer cooked texture. Cover with a lid or plastic wrap and place container at the center of the flat table. Select the program and weight then press **Start**. Open the door to **STIR WHEN TWO BEEPS HEARD** during cooking, press **Start** Pad to continue. Add salt and other seasonings after cooking, then stir.

Fish/Chicken Fish/Chicken

Menu Number	Menu	Weight						Recommended Containers
		100 g	200 g	300 g	400 g	-	-	
17	Steam Fish	100 g	200 g	300 g	400 g	-	-	microwave safe container with a lid or plastic wrap
18	Steam Chicken Pieces	100 g	200 g	300 g	400 g	-	-	

17. Steam Fish

It is suitable for cooking whole fish and fish fillets (thickness of fish should not be more than 3 cm). Select fish suitable for microwave cooking and place in a single layer in a microwave safe dish, with skin-side down. Add butter, spices, herbs, or lemon juice to flavor. Overlap thin edges of fillets to prevent overcooking. If stuffing whole fish with seasoning, cooking time may need to be extended. Shield the eye and tail area of whole fish with small amounts of aluminum foil to prevent overcooking. Cover dish securely with plastic wrap or fitted lid and place container at the center of the flat table. Select the program and weight then press **Start**. Open the door to **STIR WHEN TWO BEEPS HEARD** during cooking, press **Start** Pad to continue. Allow large amounts of fish to stand for 3 to 5 minutes after cooking before serving.

18. Steam Chicken Pieces

It is suitable for chicken piece, such as wings, drumsticks, thighs, half breast etc. Pierce the chicken pieces and marinate with gravy if needed. Put the prepared chicken pieces onto a microwave safe dish. Cover with a lid or plastic wrap and place container at the center of the flat table. Select the program and weight then press **Start**. Open the door to **STIR WHEN TWO BEEPS HEARD** during cooking, press **Start** Pad to continue.

Auto Cook Menus

(continued)

Rice

Rice

Menu Number	Menu	Weight						Recommended Containers
		1 cup	1.5 cups	2 cups	2.5 cups	-	-	
19	Rice	1 cup	1.5 cups	2 cups	2.5 cups	-	-	microwave safe container with a lid or plastic wrap
20	Risotto	0.5 cup	1 cup	2 cups	3 cups	-	-	

English

19. Rice

It is suitable for cooking plain rice. Put rice in a suitable sized microwave safe dish with tap water. See chart below.

Rice	1 cup	1.5 cups	2 cups	2.5 cups
Tap Water	300 ml	400 ml	500 ml	600 ml

Always allow at most ½ depth of volume for evaporation to prevent boiling over. Cover with a lid or plastic wrap and place container at the center of the flat table. Select the program and weight then press **Start**. Open the door to **STIR WHEN TWO BEEPS HEARD** during cooking, covered slightly, press **Start** Pad to continue. Allow rice to stand for 5-10 minutes after cooking.

Note: 1 cup = 150 g

20. Risotto

Suitable for cooking many basic risotto recipes and variations. Onions and garlic should be pre-cooked with 1 tablespoon of oil before adding rice and stock. The quantities of rice and amounts of stock, please follow the chart below. Always use arborio rice or shortgrain rice. Chicken, vegetable, beef or fish stock may be used. Stock should be boiling when added to rice otherwise cooking times may be incorrect. Cover dish securely with a lid or plastic wrap at stage 1. During the cooking time the oven will beep and instruct you to stir. Remove a lid or plastic wrap completely from dish. There is no need to re-cover for stage 2. At the end of stage 2 add grated parmesan cheese, stir through and stand for 2 to 4 minutes.

General Quantities For Cooking Risotto

Weight	Preparation (Manual Operation)	Boiling Stock	Finish
	High for 1 to 2 min. (all quantities)		High for 2 to 4 min.
0.5 cup	100 g onion ¼ tbsp. Oil	300 ml	20 g parmesan
1 cup	200 g onion ½ tbsp. Oil	550 ml	40 g parmesan
2 cups	300 g onion 1 tbsp. Oil	800 ml	60 g parmesan
3 cups	400 g onion 1½ tbsp. Oil	1100 ml	80 g parmesan

Pasta Pasta

English

Menu Number	Menu	Weight						Recommended Containers
		150 g	250 g	350 g	500 g	-	-	
21	Pasta	150 g	250 g	350 g	500 g	-	-	microwave safe container with a lid or plastic wrap
22	Instant Noodle	1 Serv.	2 Serv.	-	-	-	-	

21. Pasta

It is suitable for cooking a variety of pastas such as spaghetti, fettuccine, tagliatelle, macaroni, penne, spiral and various pasta shapes. Place the pasta into a suitable sized microwave safe dish with hot water (about 50 °C). See chart below.

Pasta Qty	150 g	250 g	350 g	500 g
Hot Water	900 ml	1200 ml	1400 ml	1800 ml
Dish Size	3 litre	3.5 litre	4 litre	4 litre

Add oil and salt, if desired, before cooking to prevent the pasta from sticking together. Cover with plastic wrap or a fitted lid. Place container at the center of the flat table. Select the program and weight then press **Start**. Open the door to **STIR WHEN TWO BEEPS HEARD** during cooking, then **REMOVE THE COVER**, press **Start** Pad to continue. Allow pasta to stand for 5 to 10 minutes after cooking if required then drain.

22. Instant Noodle

It is suitable for cooking instant noodle. Place the instant noodle and seasoning in a suitable size microwave safe casserole with tap water. See chart below.

Instant Noodle	1 Serv. (80 g)	2 Serv. (160 g)
Tap Water	450 ml	800 ml

Allow at least ½ depth of volume for evaporation to prevent boiling over. Cover with a lid or plastic wrap and place container at the center of the flat table. Select the program and weight then press **Start**. Open the door to **STIR WHEN TWO BEEPS HEARD** during cooking, touch **Start** Pad to continue.

Timer Setting (Kitchen Timer/Standing Time/Delay Time)

This feature allows you to program the oven as a kitchen timer. It can be also used to program a stand time after cooking is completed or to program a delay start.

To use as a Kitchen Timer: **Example: To count 5 minutes**

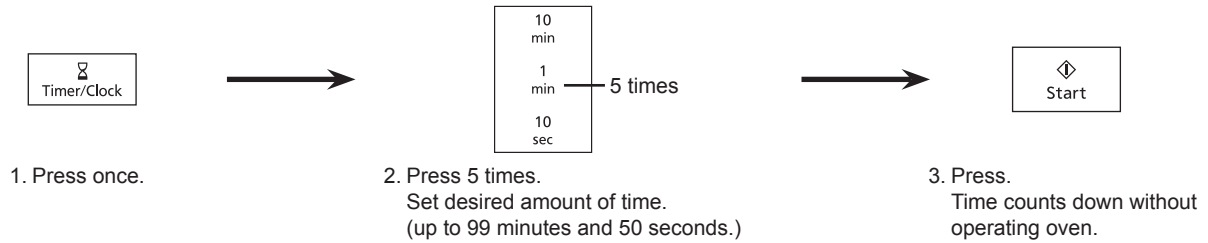

To Set Standing Time: **Example: To stand for 5 minutes after cooking**

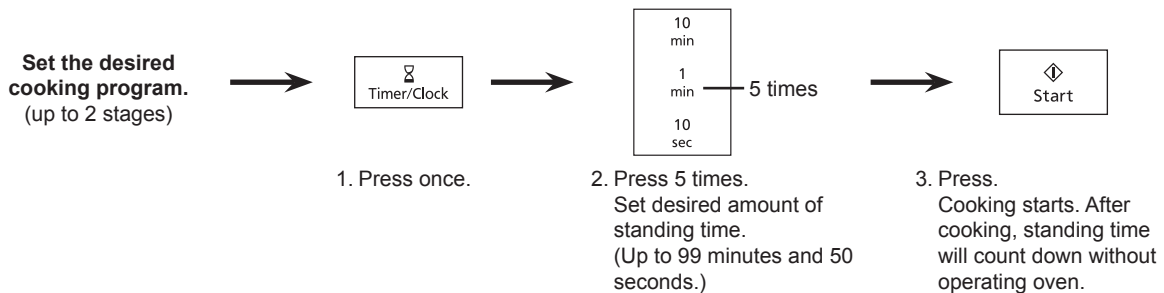

To Set Delay Time: **Example: To start cooking 5 minutes later**

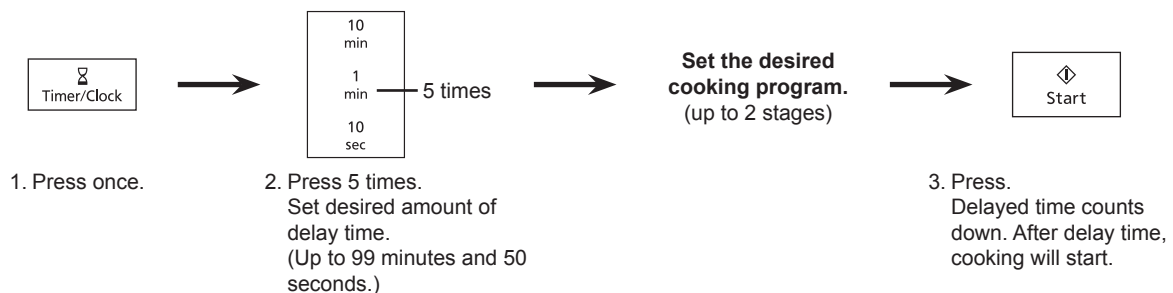

Notes:

1. If oven door is opened while Standing Time, Delay Time or Kitchen Timer has been set, the time in the display window will continue to count down.
2. Delay Time and Standing Time can not be programmed before any Auto control Function. This is to prevent the standing temperature of the food from rising before defrosting or cooking begins. A change in the starting temperature could cause inaccurate results.
3. When using Standing time or Delay time, it's up to 2 Power stages.

Before Requesting Service

English

ALL THESE THINGS ARE NORMAL:

The oven causes interference with my TV.	Some radio and TV interference might occur when you cook with the microwave oven. This interference is similar to the interference caused by small appliances such as mixers, vacuums, hair dryers, etc. It does not indicate a problem with your oven.
Steam accumulates on the oven door and warm air comes from the oven vents.	During cooking, steam and warm air are given off from the food. Most of the steam and warm air are removed from the oven by the air which circulates in the oven cavity. However, some steam will condense on cooler surfaces such as inside and/or on the oven door. This is normal and safe. Steam will disappear after the oven is cool down.
I accidentally operate my microwave oven without any food in it.	Operating the oven empty for a short time will not damage the oven. However, we do not recommend this to be done.
There are humming and clicking noises from my oven when I cook by Combination.	These noise occur as using microwave power or Grill. This is normal.
The oven has an odor and generates smoke when using Combination and Grill function.	It is essential that your oven is wiped out regularly particularly after cooking by Combination or Grill. Any fat and grease that builds up on the roof and walls of the oven will begin to smoke if not cleaned.
Some smoke will be given off from the cavity when using grill or combination for the first time.	It caused by the excessive oil in the cavity and oil used for rust protection.

PROBLEM	POSSIBLE CAUSE	REMEDY
Oven will not turn on.	The oven is not plugged in securely.	Remove plug from outlet, wait 10 seconds and re-insert.
	Circuit breaker or fuse is tripped or blown.	Contact the specified service center.
	There is a problem with the outlet.	Plug another appliance into the outlet to check if the outlet is working.
Oven will not start cooking.	The door is not closed completely.	Close the oven door securely.
	Start Pad was not pressed after programming.	Press Start Pad.
	Another program has already been entered into the oven.	Press Stop/Reset Pad to cancel the previous program and program again.
	The program has not been entered correctly.	Program again according to the Operating Instructions.
	Stop/Reset Pad has been pressed accidentally.	Program oven again.
The "🔒" appears in the Display Window.	The Child Lock was activated by pressing Start Pad 3 times.	Deactivate Lock by pressing Stop/Reset Pad 3 times.
"H00", "H97" or "H98" appears in the display window.	The display indicates a problem with microwave generation system.	Contact the specified service centre.

If it seems there is a problem with the oven, contact an authorized Service Centre.

Care of your Microwave Oven

1. The oven should be cleaned regularly and any food deposits removed.
2. Turn the oven off and remove the power plug from the wall socket before cleaning.
3. Keep the inside of the oven clean. When food splatters or spilled liquids adhere to oven walls, wipe with a damp cloth. Mild detergent may be used if the oven gets very dirty. The use of harsh detergent or abrasives is not recommended.
4. The outside oven surfaces should be cleaned with a damp cloth. To prevent damage to the operating parts inside the oven, water should not be allowed to seep into the ventilation openings.
5. Do not allow the Control Panel to become wet. Clean with a soft, damp cloth. Do not use detergents, abrasives or spray-on cleaners on the Control Panel. When cleaning the Control Panel, leave oven door open to prevent oven from accidentally turning on. After cleaning press **Stop/Reset** Pad to clear display window.
6. If steam accumulates inside or around the outside of the oven door, wipe with a soft cloth. This may occur when the microwave oven is operated under high humidity conditions and in no way indicates malfunction of the unit.
7. Always clean the Flat Table after cooling down with a mild detergent and wipe to dry.
8. When using the GRILL or cooking in the COMBINATION mode, some foods may inevitably splatter grease on to the oven walls. If the oven is not cleaned, occasionally it may start to "smoke" during use. These marks will be more difficult to clean later.
9. After GRILL or COMBINATION cooking the ceiling and walls of the oven should be cleaned with a soft cloth squeezed in soapy water. Particular care should be taken to keep the window area clean particularly after cooking by GRILL or COMBINATION. Stubborn spots inside the oven can be removed by using a small amount of microwave oven cleaner sprayed onto a soft damp cloth. Wipe onto problem spots, leave for recommended time and then wipe off.
DO NOT SPRAY DIRECTLY INSIDE THE OVEN.
A steam cleaner is not to be used for cleaning.
10. Wipe with a soft cloth when steam accumulates inside or around the outside of the oven door. This may occur when the microwave oven is operated under high humidity conditions and in no way indicates a malfunction of the unit or of microwave leakage.
11. Do not use harsh abrasive cleaners or sharp metal scrapers to clean the oven door glass since they can scratch the surface, which may result in shattering of the glass.
12. When it becomes necessary to replace the oven light, please consult a dealer to have it replaced.
13. Failure to maintain the oven in a clean condition could lead to deterioration of the surface that could adversely affect the life of the appliance and possibly result in a hazardous situation.

Technical Specifications











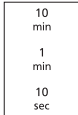





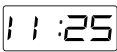

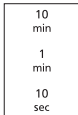





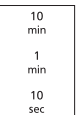

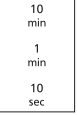

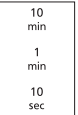

Power Source		220 V 50 Hz
Power Consumption	Microwave	4.0 A 850 W
	Grill	4.8 A 1,050 W
	Combination	7.3 A 1,600 W
Cooking Power	Microwave*	1,000 W
	Grill	1,000 W
Outside Dimensions (W × H × D)		529 mm x 326 mm x 422 mm
Oven Cavity Dimensions (W × H × D)		354 mm x 230 mm x 338 mm
Overall Cavity Volume		27 L
Operating Frequency		2,450 MHz
Net Weight		Approx. 12.7 kg

* IEC Test Procedure

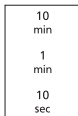
Specifications subject to change without notice.

As for the voltage requirement, the production month, country and serial number, please refer to the identification plate on the microwave oven.

Quick Guide

Feature	How to Operate	
To Set Clock (☞ page 6)		
	Press twice.	Set time of day.
		
		Press once.
To Set/Cancel Child Safety Lock (☞ page 6)	To Set: 	To Cancel: 
	Press 3 times.	Press 3 times.
		 or 
To Cook/Reheat/Defrost by Micro Power and Time Setting (☞ page 7)		
	Select power.	Set the cooking time.
		
		Press once.
To Use Turbo Defrost Pad (☞ page 8)		 or 
	Press once.	Select the weight of food.
		
		Press once.
To Cook using Grill Pad (☞ page 10)		
	Select power.	Set the cooking time.
		
		Press once.
To Cook using Combination Pad (☞ page 11)		
	Select power.	Set the cooking time.
		
		Press once.
To Cook using Auto Cook Pad (☞ page 13)		
	Select desired menu number.	Set weight.
		
		Press once.
To Use as a Kitchen Timer (☞ page 19)		
	Press once.	Set the kitchen time.
		
		Press once.
To Set Standing Time (☞ page 19)	Set the desired cooking program.	
		
	Press once.	Set the standing time.
		Press once.
To Set Delay Start (☞ page 19)		
	Press once.	Set the delay time.
		Set the desired cooking program.
		
		Press once.